

## 2.5 System-specific rules miniaturegolf



1. In general, miniaturegolf lanes have the following dimensions:  
Length: 6,25 m    Width: 0,90 m    Target circle diameter: 1,40 m
2. The authoritative drawings for standardization are kept by the WMF.
3. Only courses with standard dimensions and with 18 of the 28 standardized lanes can be approved as miniaturegolf courses. Different alternatives of the same lane type are permitted, however max. two on one course.
4. The lanes can be arranged in any order from 1 to 18
5. Mirror-image versions of lanes 1, 2, 3, 5, 11, 12, 18 and 19 are permitted.
6. The following lanes and obstacles are standardized:
  1. pyramids
  2. loop
  3. sloped circle with kidney
  4. double waves
  5. flat loop
  6. bridge
  7. jump with net
  8. straight lane with target window
  9. pipe
  10. sticks
  11. labyrinth
  12. truncated cones
  13. double wedges
  14. passages
  15. middle hill
  16. volcano
  17. "V"-obstacle
  18. angle
  19. lightning
  20. straight lane without obstacles
  21. sloped circle without obstacles
  22. plateau
  23. wedge with target window
  24. sloped lane without obstacles
  25. sloped circle with "V"-obstacle
  26. straight lane with jump
  27. rhombus
  28. straight lane with target hill

- In every target circle there must be a repositioning marking line at a constant distance of 20 cm from the boundary. Further repositioning markings are defined at each lane in the following.

- general measurements in cm

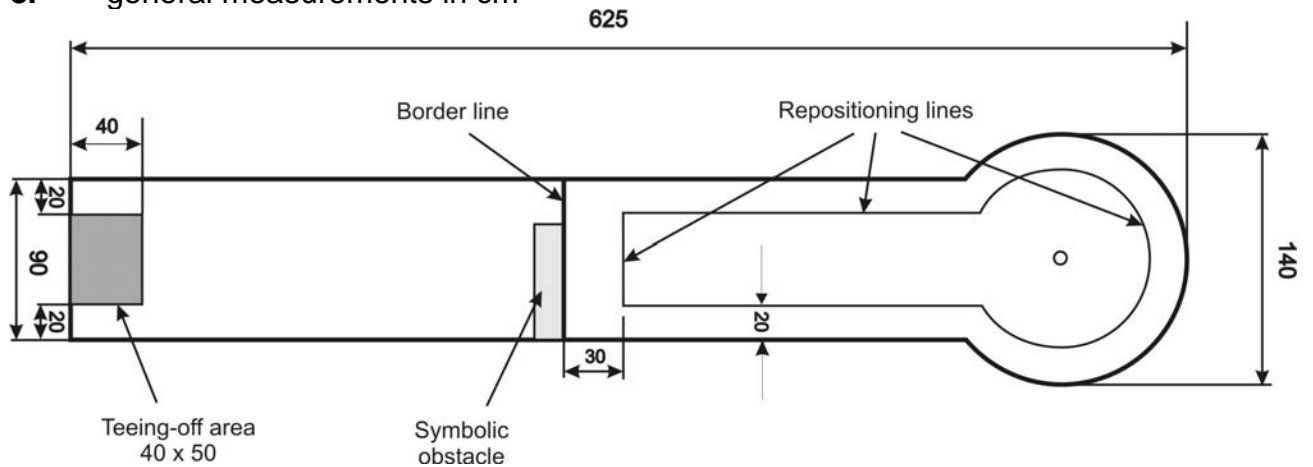

- It is not allowed to step inside the lanes (including obstacles) or to cross or jump over the lanes. It is allowed to step on the boundary when playing a stroke.

### Lane 1 pyramids

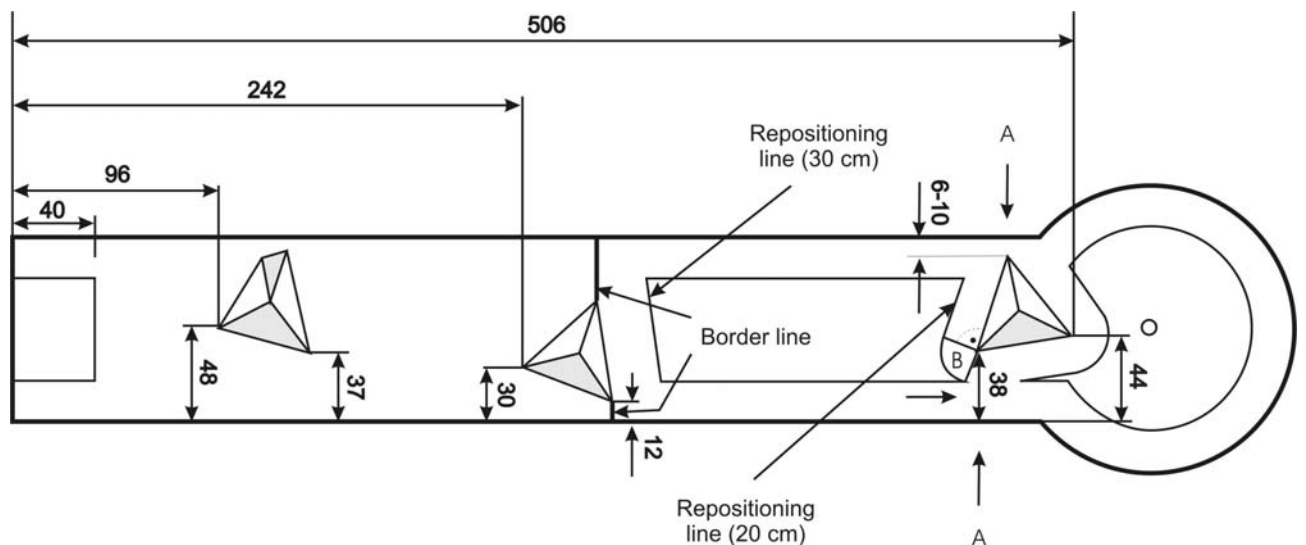

Intended path: Not laid down

Repositioning: If the ball comes to rest in sector B (see diagram) it can be repositioned at up to 20 cm radially from the pyramid. Should the space between the obstacle and the boundary be too small for the ball to be repositioned then the following regulations apply:

If the ball comes to rest in front or directly at of the narrowest part between the pyramid and the boundary (two markings A in diagram), it can be repositioned at up to 20 cm away from the boundary and the obstacle in the direction of the teeing-off area.

If the ball comes to rest behind the narrowest part, it can be repositioned at up to 20 cm away from the boundary and the obstacle in the direction of the target.

Measurements: See diagram

### Lane 2 loop

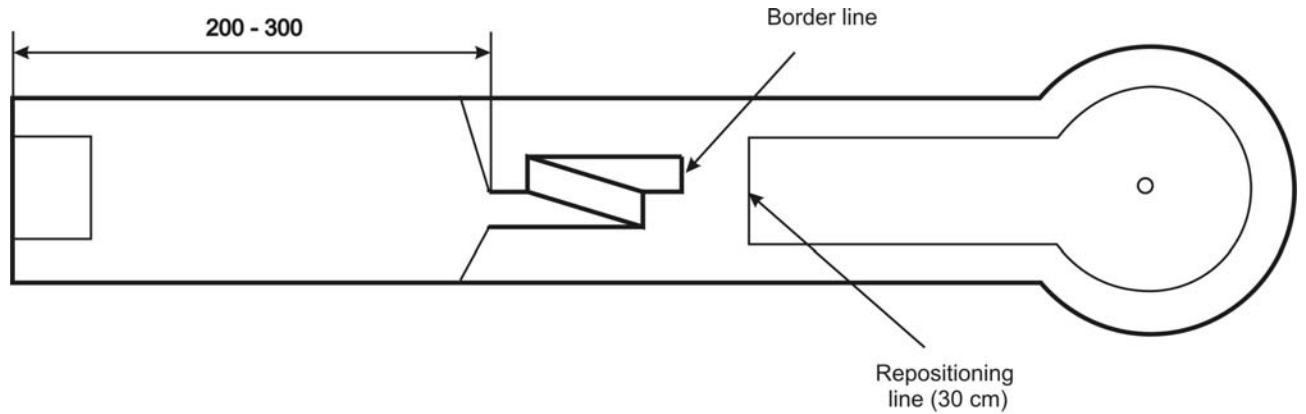

Intended path: Through the somersault

As the path of the ball is not always controllable in the somersault, the obstacle can be considered as completed if the ball correctly crosses the entrance and the exit. Even a ball which jumps from the entrance to the exit and thereby leaves out the actual somersault, is still acceptable if it leaves the exit correctly. However, should the ball jump over the outside walls of the obstacle, it has left the intended path.

Measurements: beginning of obstacle 200 – 300 cm from beginning of the lane  
width of obstacle 15 – 22 cm

### Lane 3 sloped circle with kidney

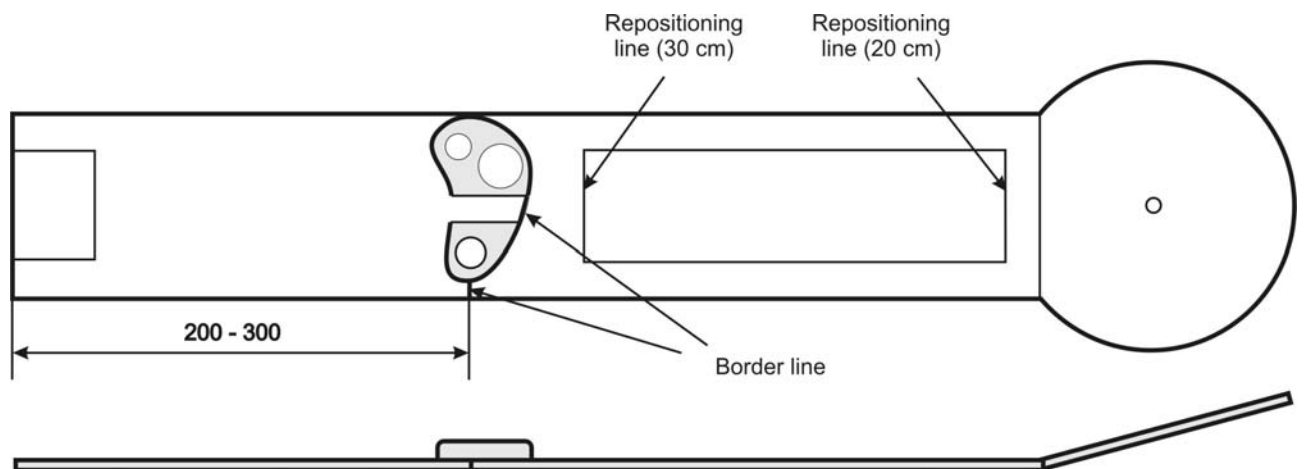

Intended path: Either through the tunnel as a straight stroke or passing the obstacle on the side

Measurements: center of obstacle 200 – 300 cm from beginning of the lane  
 width of obstacle in the middle 15 – 22 cm  
 at boundary 8 – 13 cm

**Lane 4 double waves**

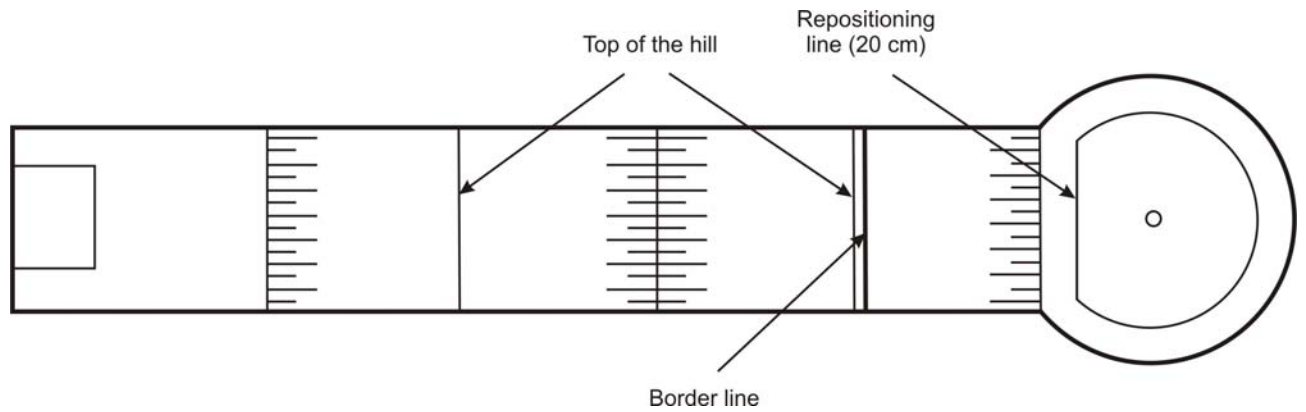

Intended path: Not laid down

Border line: Right after the top of the second hill

**Lane 5 flat loop**

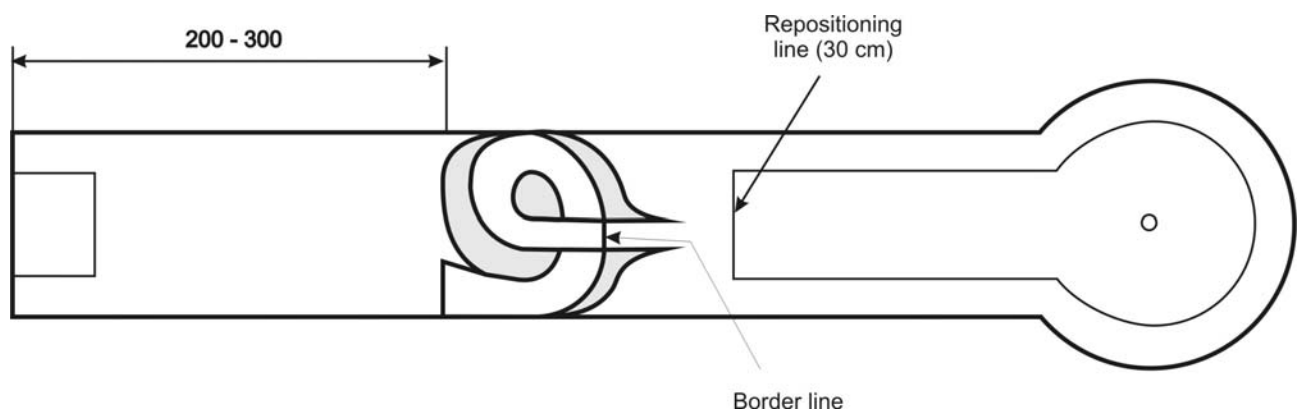

Intended path: The ball must go through the entrance and the complete length of the loop up until the border line. The ball leaves the intended path if it jumps over the raised sides before the border line, or if it leaves out the loop.

Measurements: beginning of obstacle 200 – 300 cm from beginning of the lane

### Lane 6 bridge

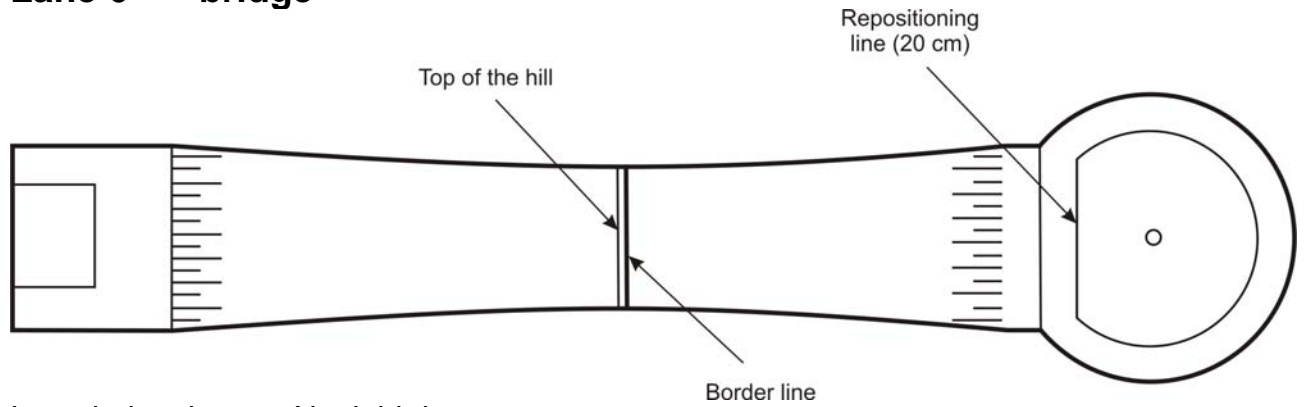

Intended path: Not laid down  
 Border line: Right after the top of the hill

### Lane 7 jump with net

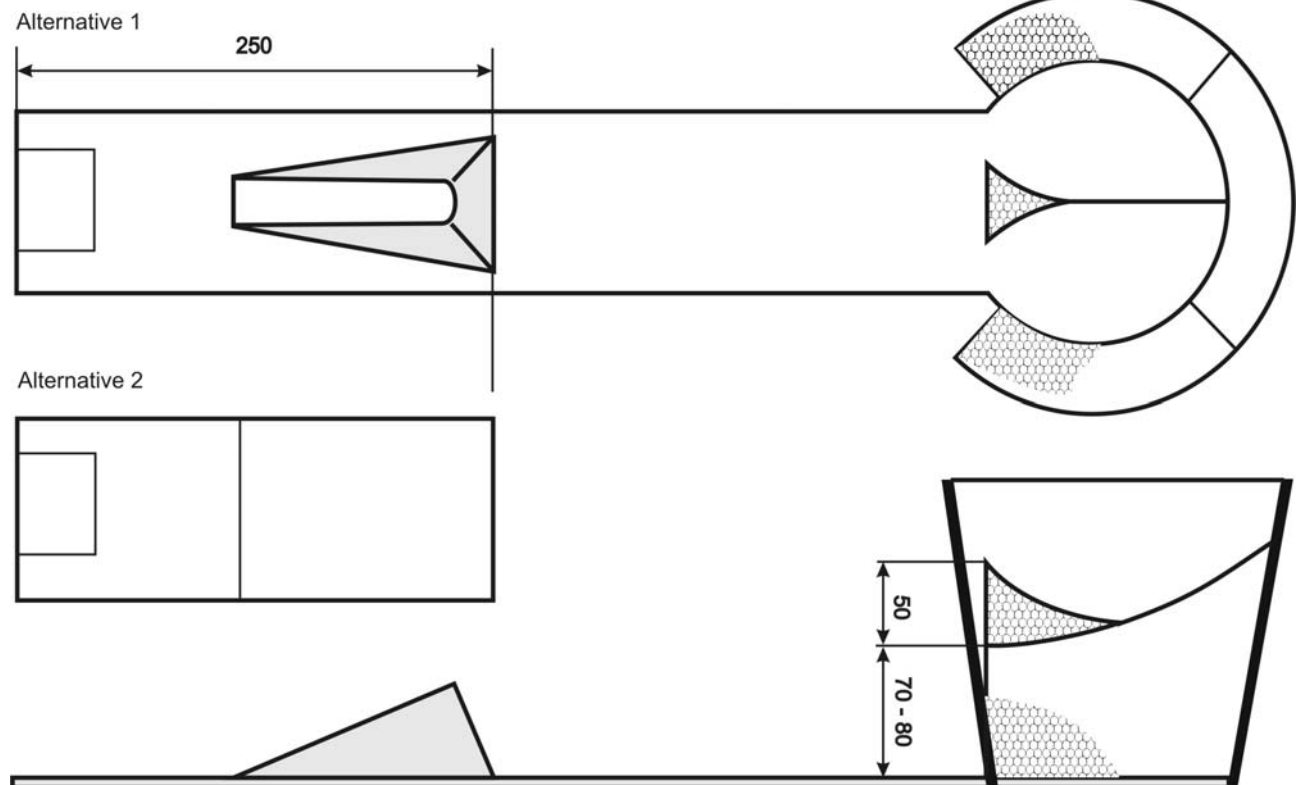

Intended path: The direct line of flight from the teeing-off area touching the ski-jump into the net

Measurements: Net ring 50 cm in diameter  
 End of obstacle 250 cm from beginning of the lane  
 distance between teeing-off level and lower edge of ring: 70 - 80 cm.

Border line: Lane without border line  
 Target: The inside of the net

Lane-specific rule: It is allowed to step inside the lane for retrieving the ball.

Others: Lane structure between ramp and target is not required.

**Lane 8 straight lane with target window**

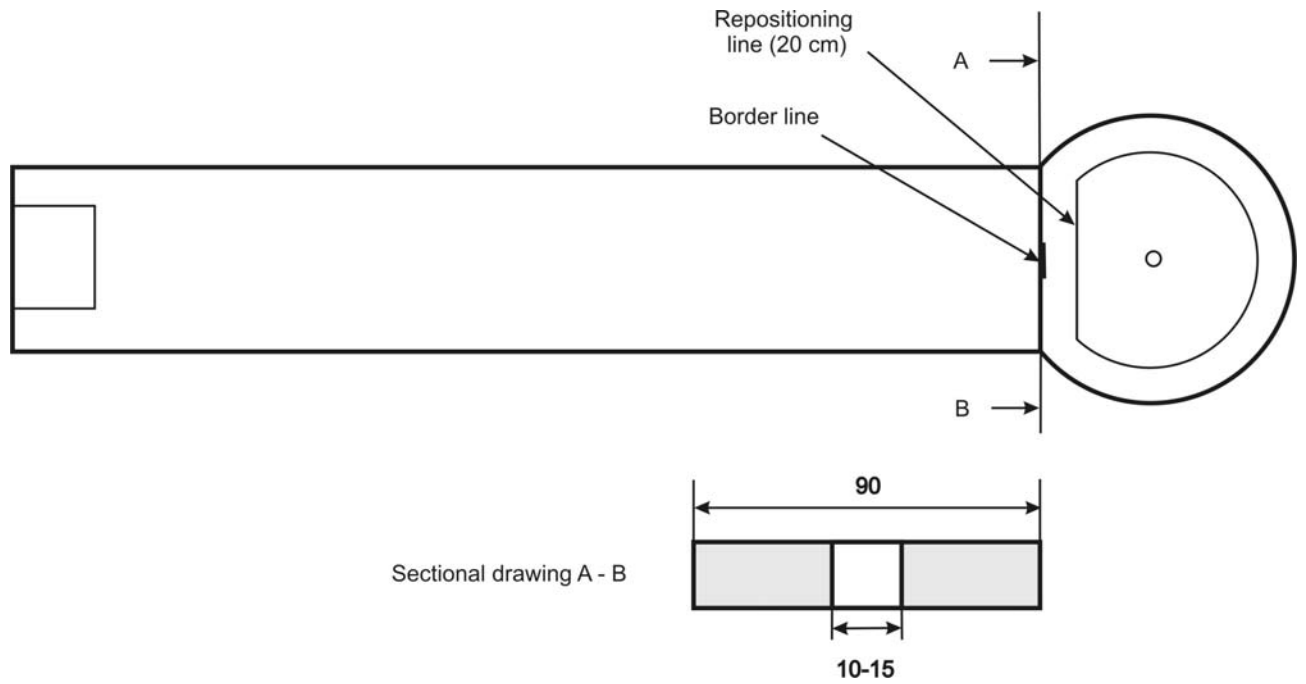

Intended path: Through the window

Measurements: Rear edge of obstacle 500 cm from the beginning of the lane  
 width of obstacle 10 – 15 cm

**Lane 9 pipe**

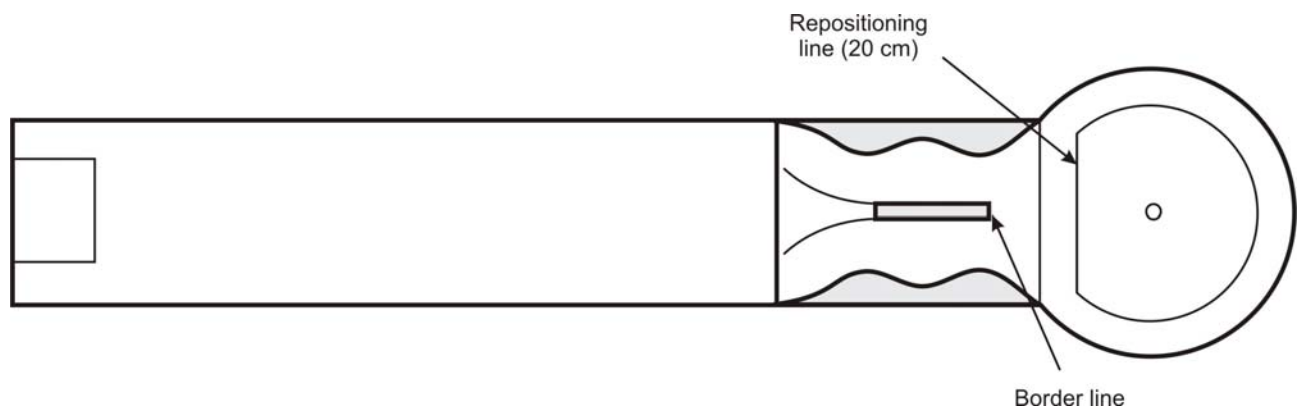

Intended path: Only through the pipe

Measurements: Rear edge of obstacle 500 cm from the beginning of the lane  
 diameter of the pipe 4,5 – 6,5 cm

Border line: Right at the exit of the pipe

## Lane 10 sticks

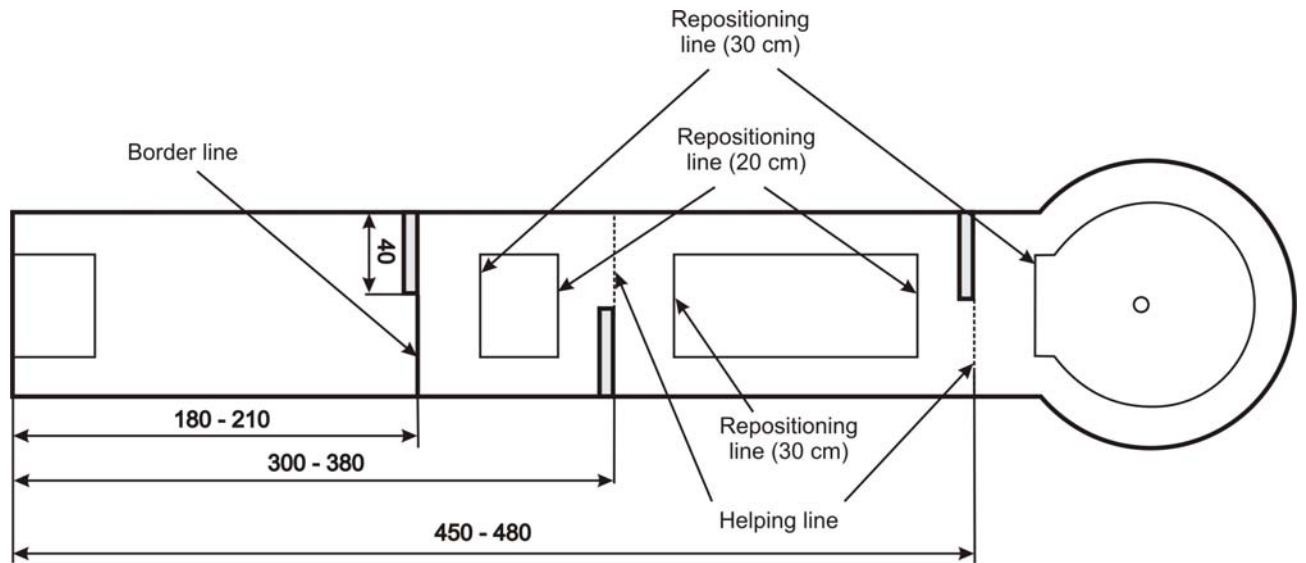

Intended path: Between the obstacles (not over them).

Measurements: see diagram

Helping line: A helping line is marked right at the end of the second and third obstacle.

Alternatives: Position of each stick can be on left or right side.  
Third stick can be excluded.  
On each side has to be at least one stick.

Repositioning: If the ball comes to rest close before or on the helping line with its point of contact, it can be repositioned at up to 20 cm from the obstacle in the direction of the teeing-off area. If it has passed the helping line, it can be repositioned at up to 30 cm from the obstacle in the direction of the target.

## Lane 11 labyrinth



- Intended path: Although the obstacle has four entrances, only the second entrance from the right-hand side (left-hand side at mirror-image version) leads to the target. The remaining entrances must be blocked in such a way as to prevent the ball from reaching the target.
- Measurements: width of gate 12 - 20 cm
- Border line: Lane without border line.
- Target: The target area is defined by the area between the parallel vertical irons in the center of the labyrinth only (see diagram). It can be designed with or without target hole.

## Lane 12 truncated cones

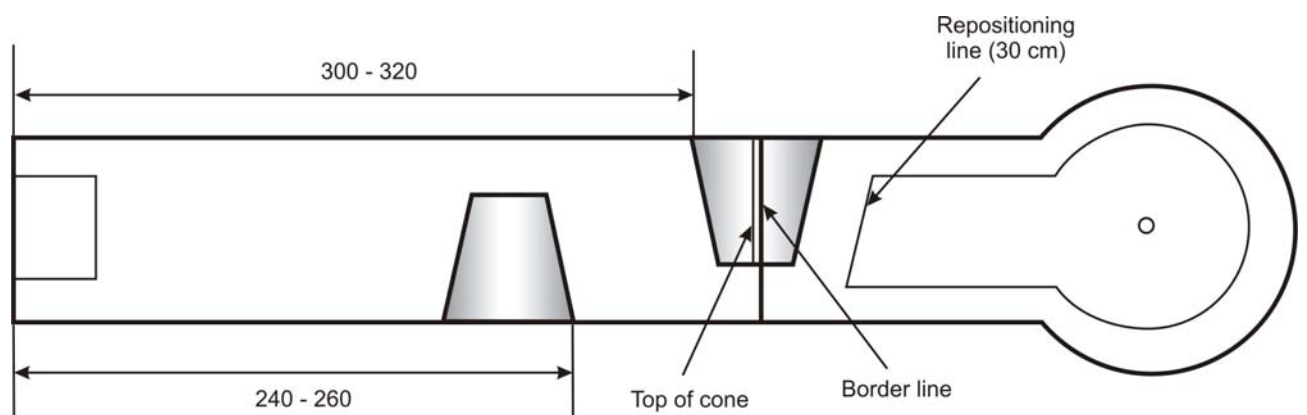

- Intended path: Not laid down.
- Measurements: see diagram
- Border line: Right after the top of the second cone prolonged to the opposite frame



### Lane 13 double wedges

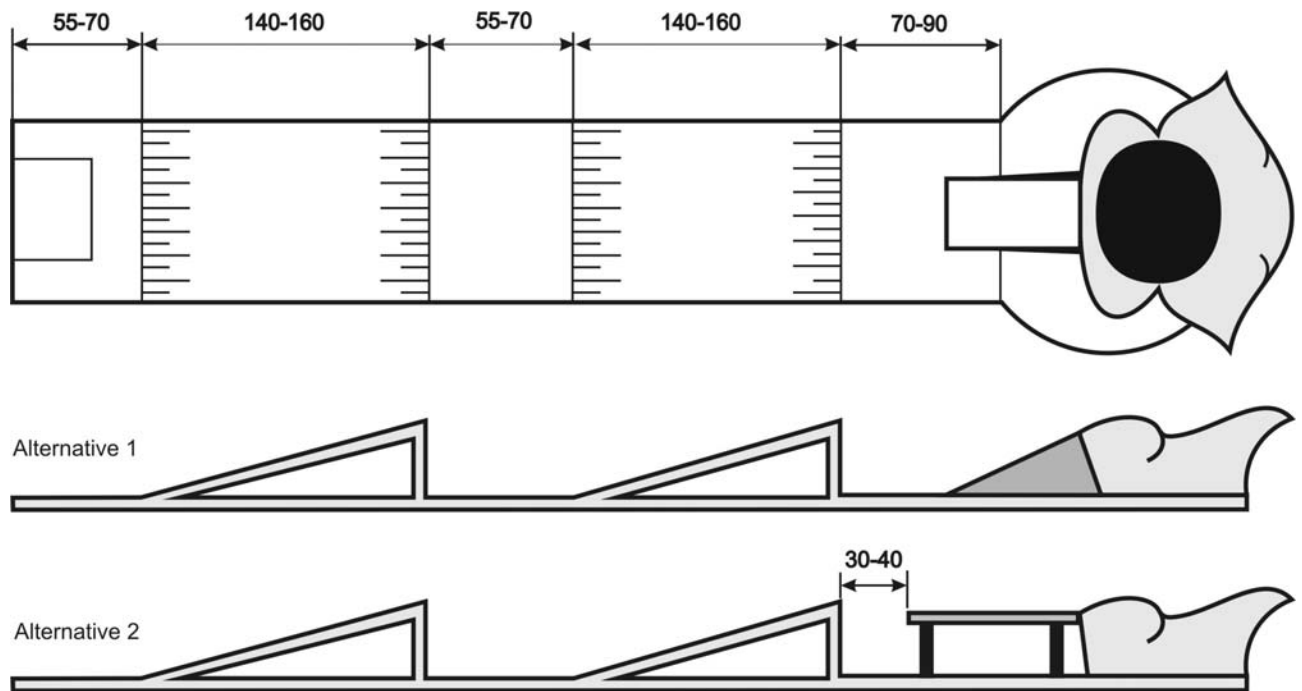

Intended path: Not laid down.

Measurements: Width of entrance to the bowl 12 – 25 cm (both alternatives)  
Others see diagram

Border line: Lane without border line.

Target: Inside the bowl, which means the ball is lying on the bottom of the bowl or on the filling material, if such is used.

Lane-specific rule: It is allowed to move the sand / gravel / other filling material in the bowl. However it is not allowed to add or remove filling material into or from the bowl.  
It is allowed to step inside the lane for retrieving the ball.

### Lane 14 passages

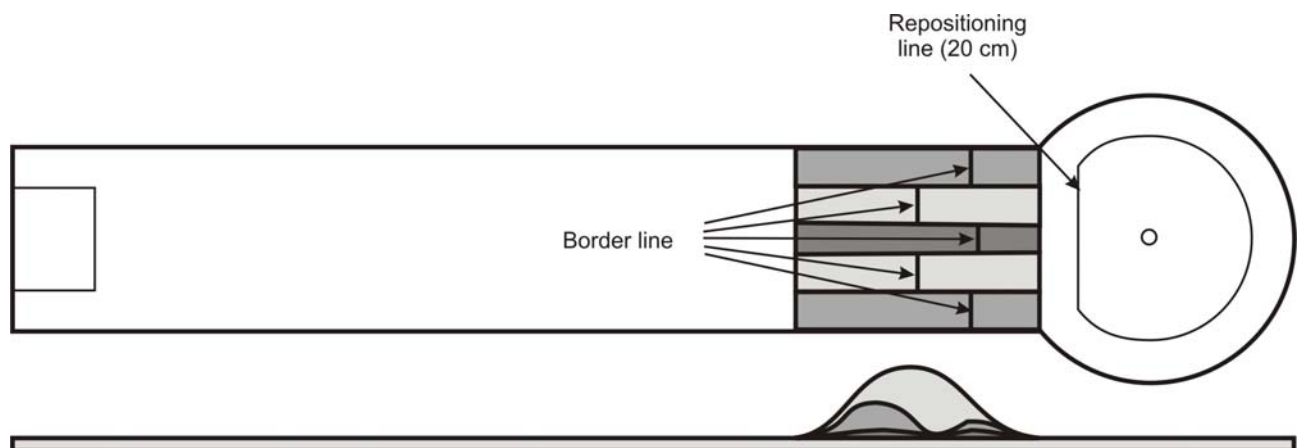

Intended path: Not laid down

Measurements: Rear edge of obstacle 500 cm from the beginning of the lane

Border line: Right after the top of the last hill in each passage

## Lane 15 middle hill

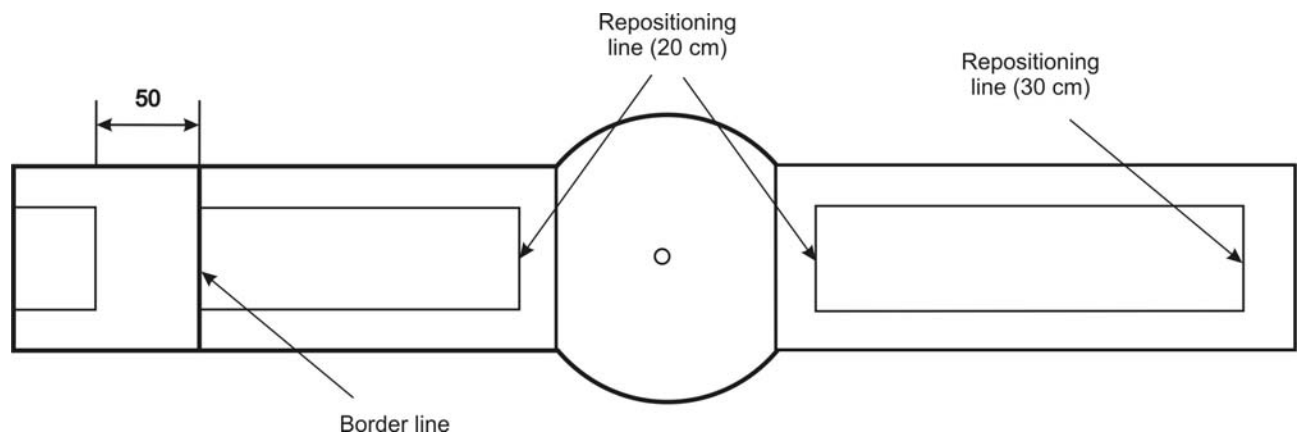

Intended path: Not laid down.

Alternative: Shape of the hill part with boundaries, which are parallel with the boundaries of the flat part of the lane.

Repositioning: If the ball comes to rest on the hill it can be repositioned at up to 20 cm from the hill parallel to the boundary line in the direction from which it has come from. It can also be played from the point on the hill where it has come to rest.

Border line Border line is marked 50 cm ahead the teeing-off area.

## Lane 16 volcano

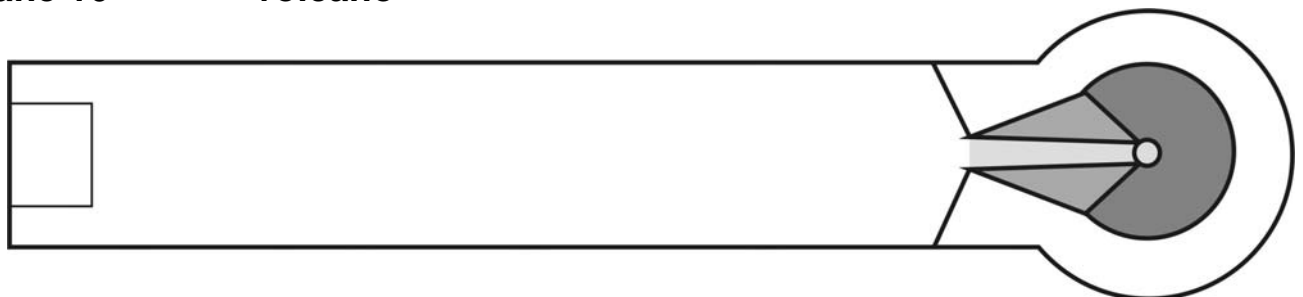

Intended path: Not laid down

Border line: Lane without border line

Alternatives: 1 Shape as picture above  
2 Shape as picture below

Width of obstacle 15 – 20 cm  
 Length of slot 7,5 – 9,5 cm.  
 Shape of obstacle could also be identical with the full obstacle of feltgolf lane 9, Örkelljunga

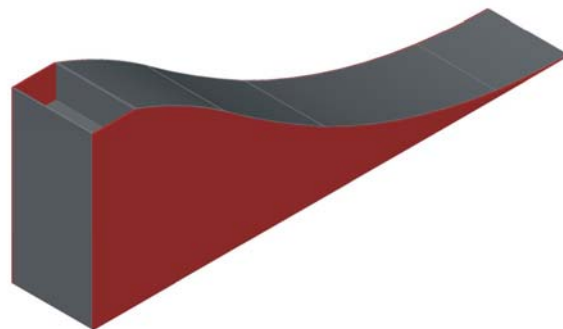
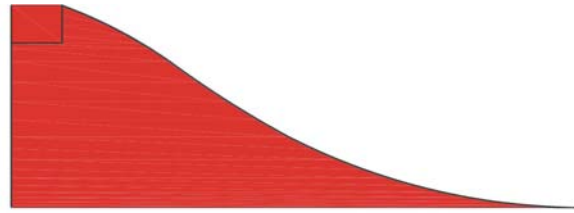

Target: The target hole (alternative 1 + 2) and the complete plateau (only for alternative 1)

Measurements: As a result of the position of the obstacle the target hole should be placed in the middle of the target circle.

Lane-specific rule: It is allowed to step inside the lane for retrieving the ball.

### Lane 17 "V"-obstacle

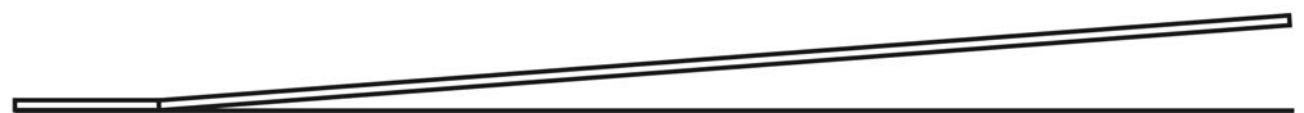
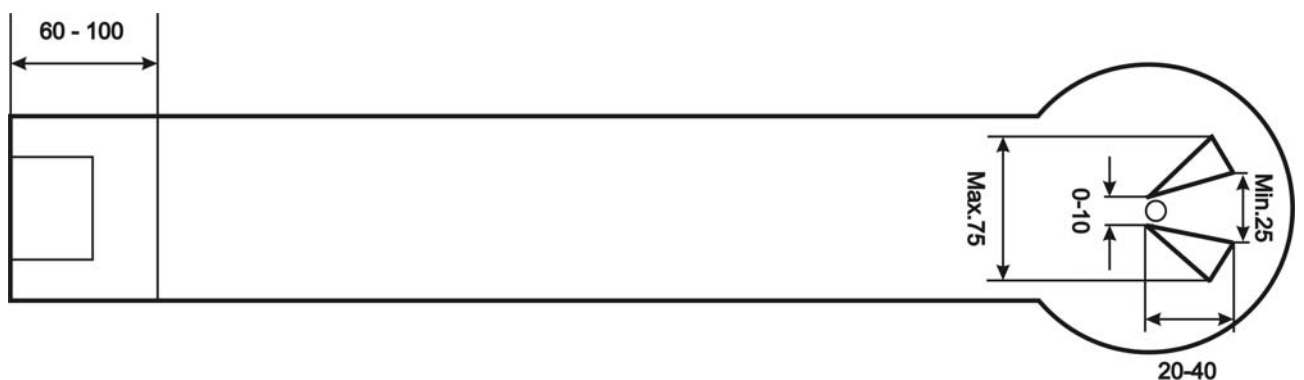

Intended path: Not laid down, but ball is not allowed to jump over obstacles.

Measurements see drawing

- Alternatives:
- 1 Obstacles are linear sticks
  - 2 Obstacles are triangles (see drawing)
  - 3 Two sticks or triangles are close together at the bottom with target hole
  - 4 Two sticks or triangles are close together at the bottom without target hole (target can be a round mould)

Border line: Lane without border line.

### Lane 18 angle

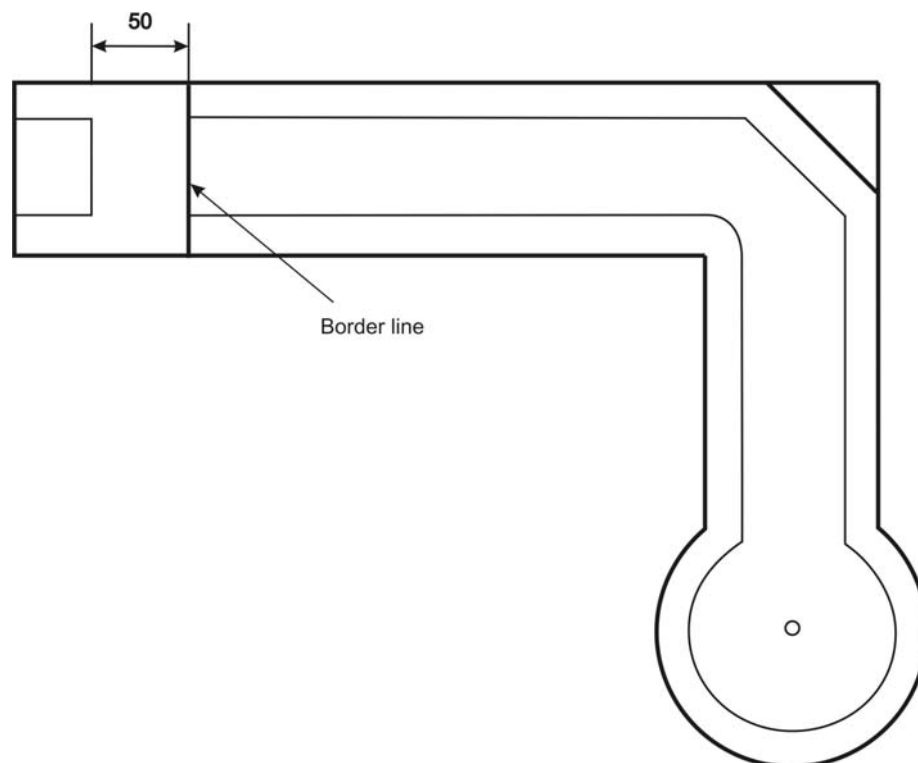

Intended path: Not laid down.

Border line: Border line is marked 50 cm ahead the teeing-off area.

Measurements: Length of obstacle 40 – 60 cm

**Lane 19 lightning**

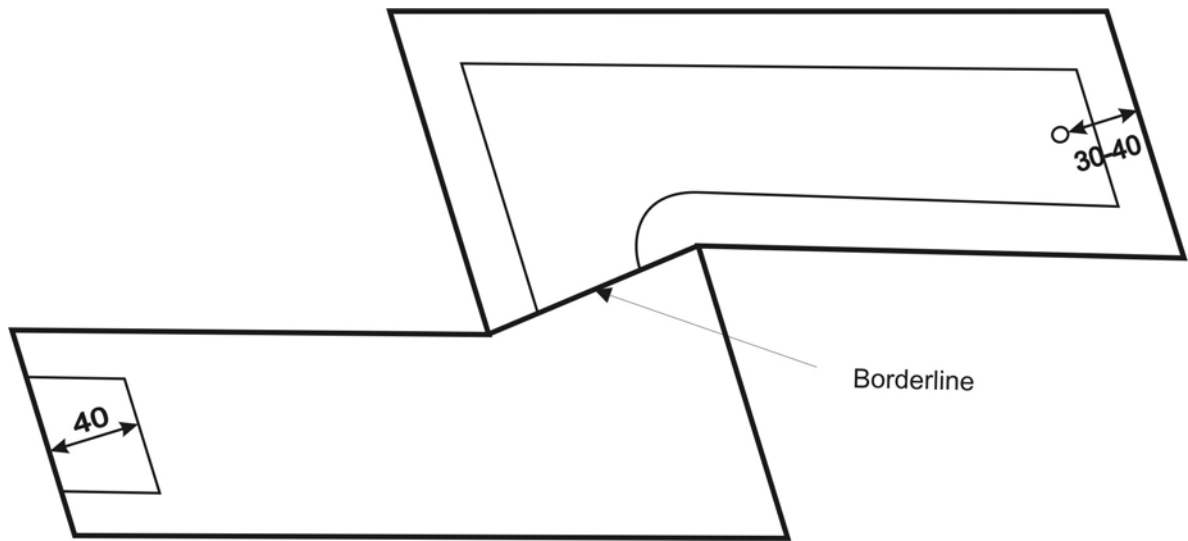

Intended path: Not laid down

**Lane 20 straight lane without obstacles**

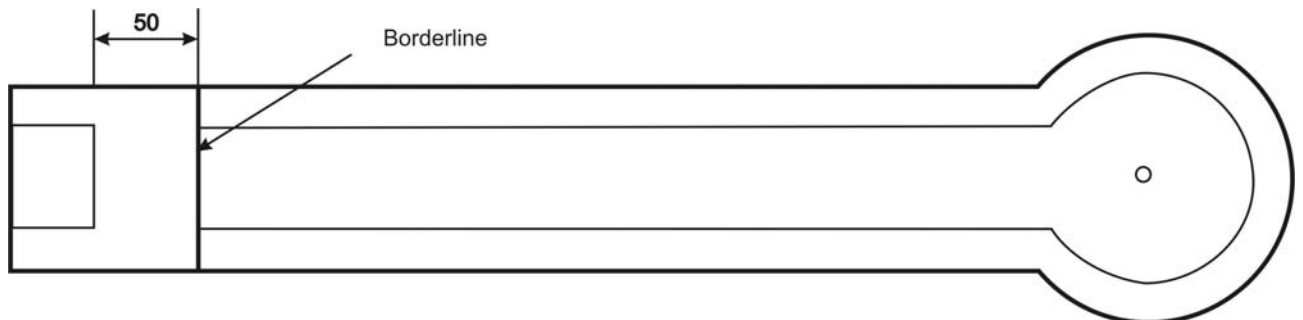

Intended path: Not laid down.

Border line Border line is marked 50 cm ahead the teeing-off area.

**Lane 21 sloped circle without obstacles**

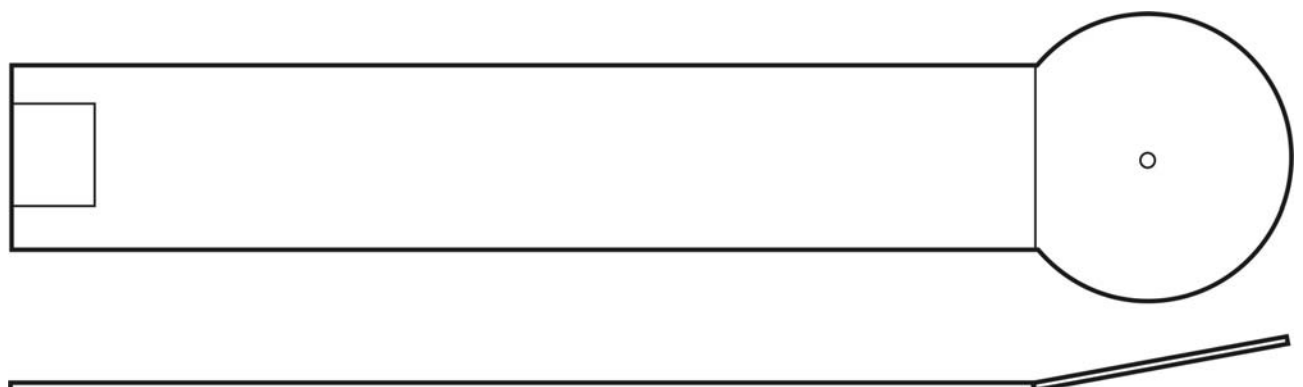

Intended path: Not laid down.

Border line: Lane without border line.

### Lane 22 plateau

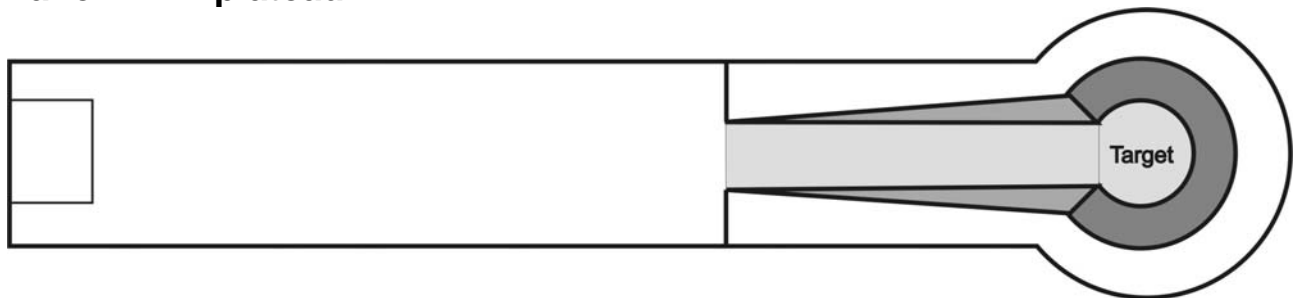

Intended path: Not laid down.

Measurements:	beginning of obstacle	250–350 cm from beginning of the lane
	width of ramp entrance	12 – 25 cm
	Rear edge of plateau frame	0,8 – 1,7 cm
	Position of center of plateau	500–600 cm from beginning of the lane

Border line: Lane without border line

Target: Target area can be rectangular or round.

Others: Full course under the ramp is not requested.

Lane-specific rule: It is allowed to step inside the lane for retrieving the ball.

### Lane 23 wedge with target window

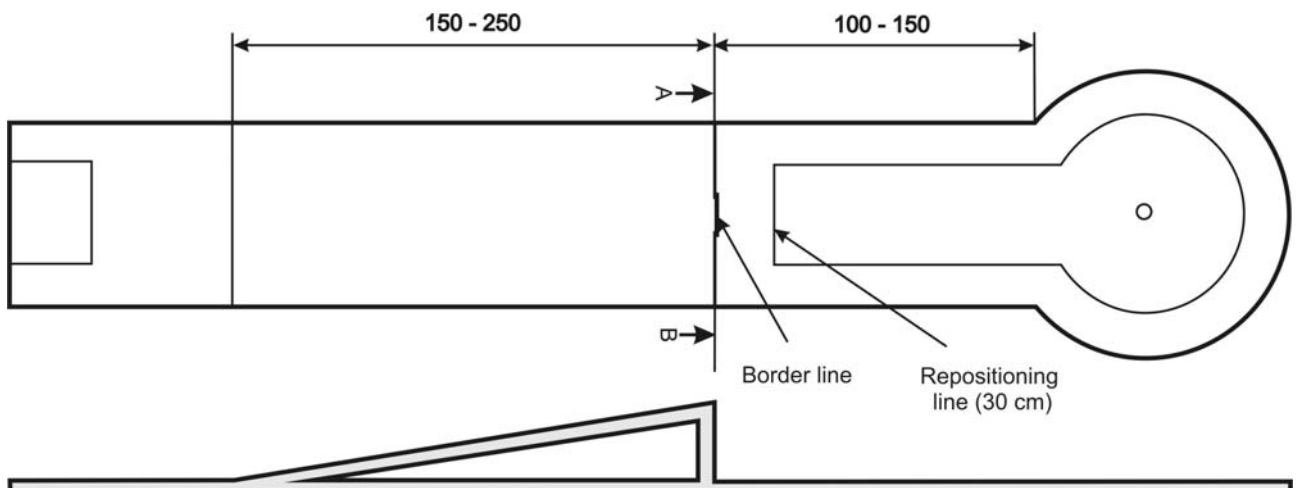

Sectional drawing A - B

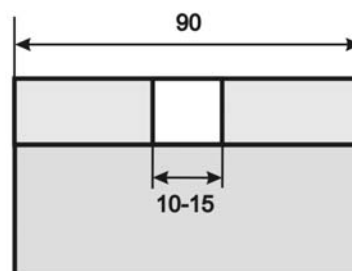

Intended path: Through the window  
 Measurements: Width of obstacle 10 – 15 cm  
 Others see diagram

**Lane 24 sloped lane without obstacles**

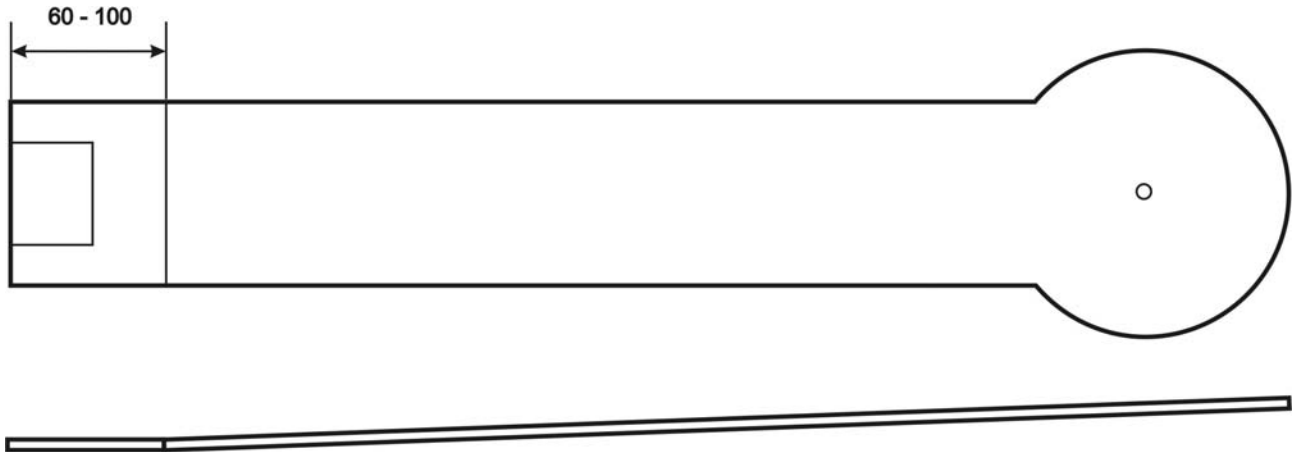

Intended path: Not laid down  
 Border line: Lane without border line

**Lane 25 sloped circle with "V"-obstacle**

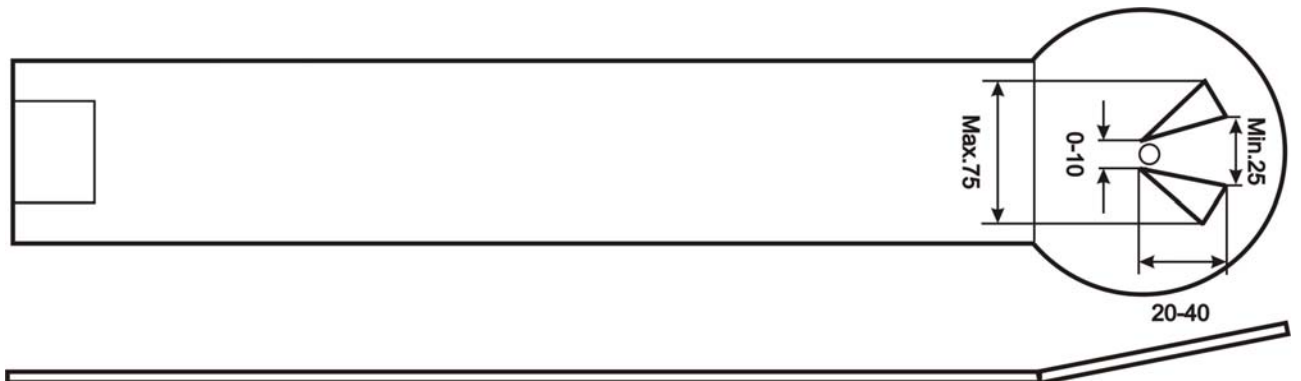

Intended path: Not laid down, but ball is not allowed to jump over obstacles.

Measurements see drawing

- Alternatives:
- 1 Obstacles are linear sticks
  - 2 Obstacles are triangles (see drawing)
  - 3 Two sticks or triangles are close together at the bottom with target hole
  - 4 Two sticks or triangles are close together at the bottom without target hole (target can be a round mould)

Border line: Lane without border line.

## Lane 26 straight lane with jump

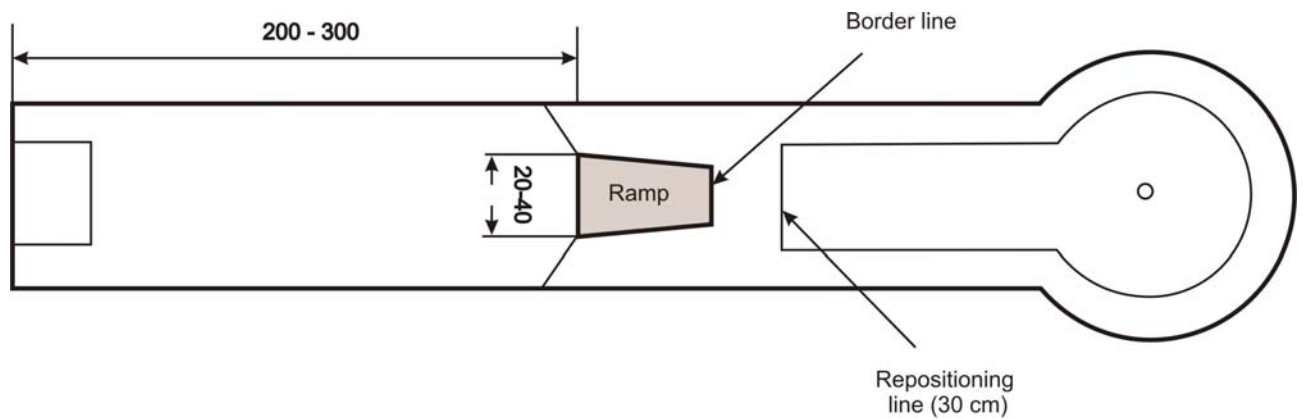

Intended path: Over the ramp

Measurements: See drawing

Border line: Border line is marked at the end of the ramp

Others: The ramp can be a regular or an irregular rectangle

## Lane 27 rhombus

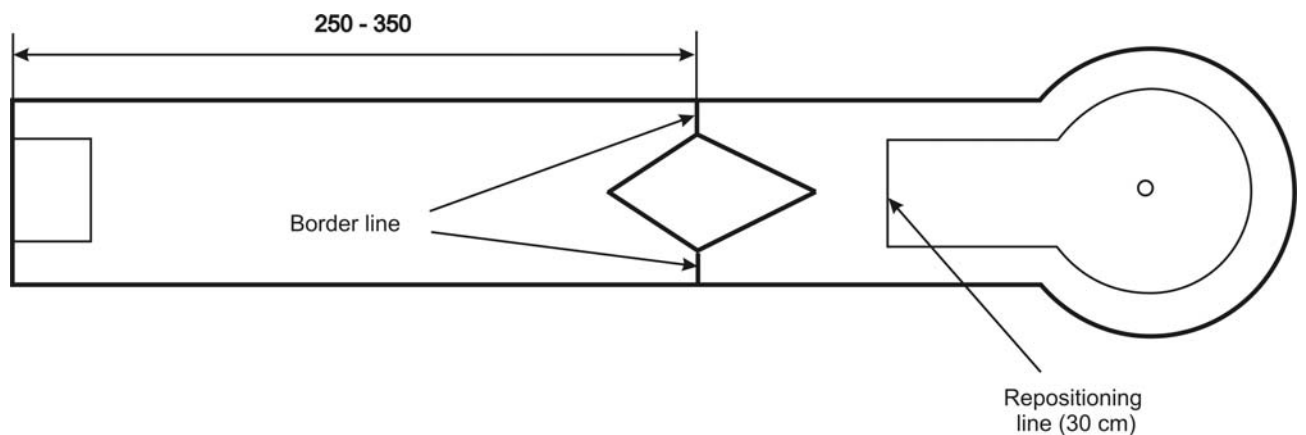

Intended path: Not laid down.

Measurements: Width of sideways 10 – 15 cm

Alternatives:

- 1 shape as picture above
- 2 shape turned 180 degrees
- 3 shape symmetrical

Border line: Border line is marked each side just behind the point with smallest distance to the frame



## Lane 28 straight lane with target hill

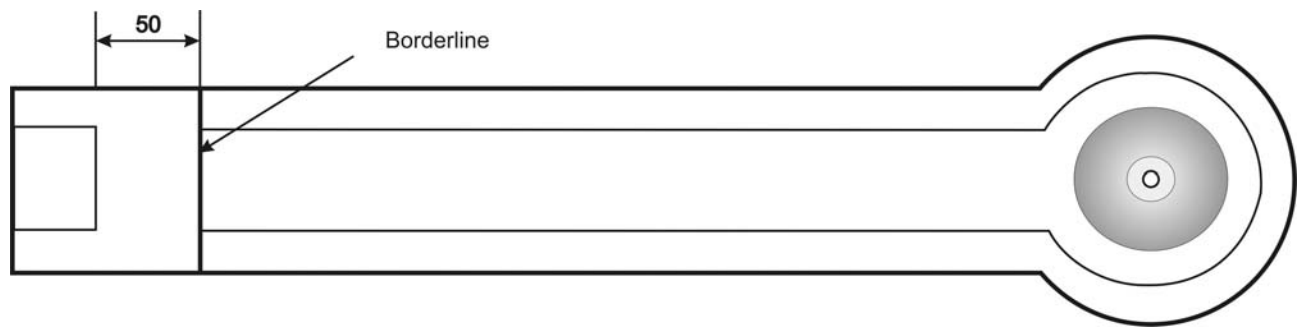

Intended path: Not laid down.

Measurements: Height of the target hill with same shape as lane 8 concrete  
10 – 20 cm

Diameter of the hill 40 – 60 cm

Border line: Border line is marked 50 cm ahead the teeing-off area.